

Module for emergency stops, end position monitoring for movable guards and magnetic safety sensors

Main features

- For safety applications up to SIL CL 3/PL e
- Input with 1 or 2 channels
- Choice between automatic start, manual start or monitored start
- Connection of input channels of opposite potentials
- Reduced housing width of 22.5 mm
- Output contacts:
2 NO safety contacts,
1 NC auxiliary contact
- Supply voltage:
10 ... 30 Vdc, 24 Vac/dc, 120 Vac, 230 Vac

Utilization categories

Alternating current: AC15 (50...60 Hz)

U_e (V) 230

I_e (A) 3

Direct current: DC13 (6 oper. cycles/min.)

U_e (V) 24

I_e (A) 4

Quality marks and certificates:



EC type examination certificate: IMQ CP 432 DM

UL approval: E131787

CCC approval: 2013010305640211

EAC approval: RU C-IT.AQ35.B.00454

Compliance with the requirements of:

Low Voltage Directive 2014/35/EU,

Machinery Directive 2006/42/EC,

EMC Directive 2014/30/EU

Technical data

Housing

Polyamide housing PA 66, self-extinguishing V0 acc. to UL 94

Protection degree:

IP40 (housing), IP20 (terminal strip)

Dimensions:

see page 295, design A

General data

SIL CL:

up to SIL CL 3 acc. to EN 62061

Performance Level (PL):

up to PL e acc. to EN ISO 13849-1

Safety category:

up to cat. 4 acc. to EN ISO 13849-1

Safety parameters:

see page 349

Ambient temperature:

-25°C...+55°C

Mechanical endurance:

>10 million operating cycles

Electrical endurance:

>100,000 operating cycles

Pollution degree:

external 3, internal 2

Impulse withstand voltage (U_{imp}):

4 kV

Rated insulation voltage (U_i):

250 V

Overvoltage category:

II

Weight:

0.3 kg

Supply

Rated supply voltage (U_n):

10 ... 30 Vdc

24 Vac/dc; 50...60 Hz

120 Vac; 50...60 Hz

230 Vac; 50...60 Hz

Max. DC residual ripple in DC:

10%

Supply voltage tolerance:

-10% ... +15% of U_n

Power consumption AC:

< 5 VA

Power consumption DC:

< 2 W

Control circuit

Protection against short circuits:

PTC resistance, I_h=0.5 A

PTC times:

response time > 100 ms, release time > 3 s

Maximum resistance per input:

≤ 50 Ω

Current per input:

30 mA (typical)

Min. duration of start impulse t_{MIN}:

> 100 ms, > 50 ms (E02)

Response time t_A:

< 50 ms, < 150 ms (E02)

Release time t_{R1}:

< 20 ms

Release time in absence of power supply t_R:

< 70 ms, < 100 ms (E02)

Simultaneity time t_C:

unlimited

In compliance with standards:

EN 60204-1, EN ISO 13855, EN 1037, EN ISO 12100, EN ISO 13850, EN 60529,

EN 61000-6-2, EN 61000-6-3, EN 61326-1, EN 60664-1, EN 60947-1, EN ISO 13849-1,

EN ISO 13849-2, EN 62061, UL 508, CSA C22.2 n° 14-95

Output circuit

Output contacts:

2 NO safety contacts,

1 NC auxiliary contact

Contact type:

forcibly guided

Material of the contacts:

gold-plated silver alloy

Maximum switching voltage:

230/240 Vac; 300 Vdc

Max. current per contact:

6 A

Conventional free air thermal current (I_{th}):

6 A

Max. total current Σ I_{th}²:

72 A²

Minimum current:

10 mA

Contact resistance:

≤ 100 mΩ

External protection fuse:

4 A

The number and the load capacity of output contacts can be increased by using expansion modules or contactors. See page 241-250.

Code structure

CS AR-01V024

Connection type	
V	Screw terminals
M	Connector with screw terminals
X	Connector with spring terminals

Supply voltage	
024	24 Vac/dc
120	120 Vac
230	230 Vac
E02	10 ... 30 Vdc

Stock items

CS AR-01V024

CS AR-01V120

CS AR-01VE02

Features approved by UL

Rated supply voltage (U_n): 24 Vac/dc; 50...60 Hz
120 Vac; 50...60 Hz
230 Vac; 50...60 Hz

Power consumption AC: < 5 VA

Power consumption DC: < 2 W

Maximum switching voltage: 230 Vac

Max. current per contact: 6 A

Utilization category: C300

Notes:
- Use 60 or 75 °C copper (Cu) conductors, rigid or flexible, wire size 30-12 AWG.
- Tightening torque for terminal screws of 5-7 lb in.
- Only for 24 Vac/dc versions: power supply only with class 2 sources or with limited voltage and energy. (Supply from Remote Class 2 Source or limited voltage limited energy).



Safety module CS AR-01

Pin assignment

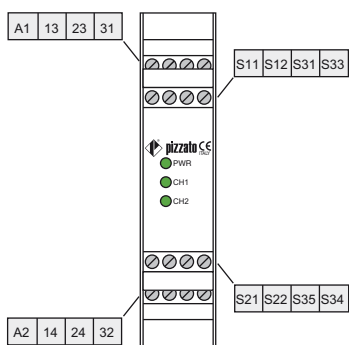

Internal block diagram

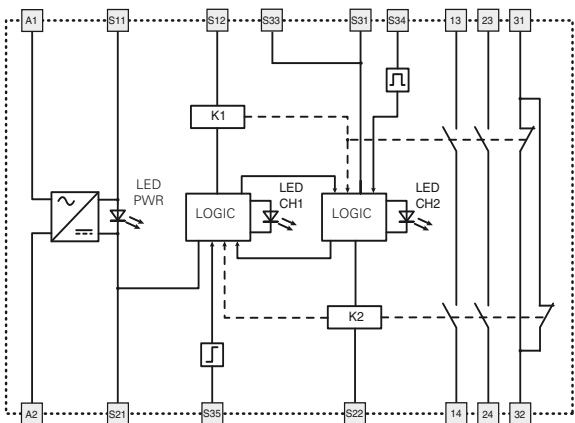

Input configuration

Emergency stop circuits	
Input configuration with manual start	
1 channel	2 channels

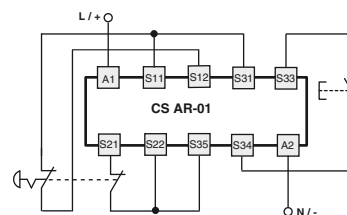
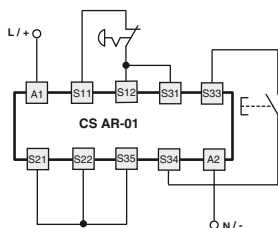

The diagram does not show the exact position of the terminals in the product

Automatic start

With regard to the indicated diagrams, bridge the start button between S33 and S34 in order to activate the automatic start module.

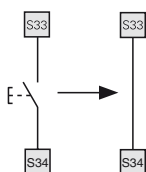

Monitored start

With regard to the indicated diagrams, remove the connection between S22 and S35 in order to activate the monitored start module.

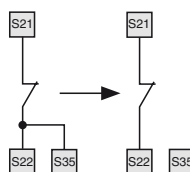

Monitoring of movable guards and magnetic safety sensors

The safety module can monitor emergency stop circuits, control circuits for movable guards as well as magnetic safety sensors. Replace the emergency stop contacts with switch contacts or sensor contacts. The sensors can only be used in 2-channel configuration.

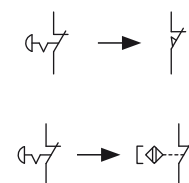

Function diagrams

Configuration with automatic start

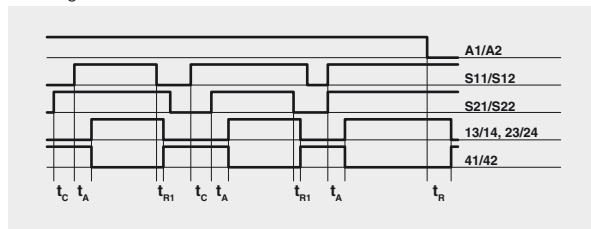

Configuration with monitored start

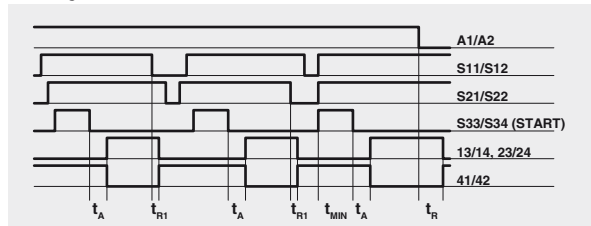

Configuration with manual start

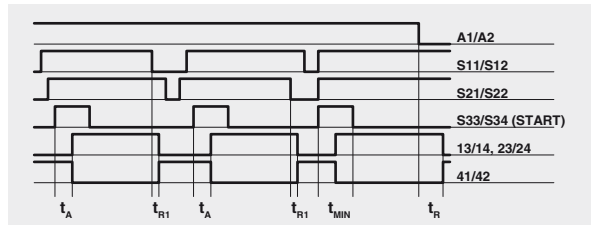

Legend:

- t_{MIN} : Min. duration of start impulse
- t_c : simultaneity time
- t_A : response time
- t_{R1} : release time
- t_R : release time in absence of power supply

Notes:

The configurations with one channel are obtained taking into consideration the S11/S12 input only. In this case it is necessary to consider time t_{R1} referred to input S11/S12, time t_R referred to the supply, time t_A referred to the start, and time t_{MIN} referred to the start.